



ATTACHMENTS

AND ACCESSORIES

INNOVATION WITH TRADITION FOR LIFE.

DURABLE EQUIPMENT VIABLE SOLUTIONS



For more than 50 years, Hauer has been developing and manufacturing loader attachments in Lower Austria. State-of-the-art technology and many years of experience are the basis for the traditionally high quality of Hauer products. Hauer attachments stand out for their exceptional longevity and value for money. The use of proper and top-quality materials in combination with the right design and a countless number of small details is instrumental in the manufacture of attachments for agriculture and forestry.

Furthermore, perfect welds applied in a perfect position by robotic systems guarantee a long service life and an optimum operating weight. Finally, Hauer attachments are touched up by a two-component paint finish that is dried by heated air to give effective protection from corrosion for many years to come. Attachments come in the standard Hauer orange and matt black livery; special colour schemes are available on request.



THE PERFECT SOLUTION FOR ALL CARRIAGES

STANDARD HOOKS

Choose between the tried and tested Hauer hooks which stand out for their robust, snug-fit design and the universal EURO hooks that are also available for all Hauer attachments.



Hauer hooks



EURO hooks

HOOKS FOR OTHER BRANDS

Hauer attachments are also available with bespoke hooks that suit a wide range of loader makes and models. Hauer pays particular attention to the correct linkage angle for a perfectly functioning parallel guidance.

- Compact loaders (wheeled, skid-steer, telescopic)
- Other front loader makes





EARTH BUCKET – ES

- Curved design for easy removal of sticky materials
- Right-angle rear edge for scraping in reverse
- High-grade and hard-wearing steel cutting edge (approx. 450 HB)
- Optional bucket teeth
- A second cutting edge is an option

Width mm	Weight kg	Cutting edge mm	Volume m ³	Height mm	Depth mm
1200	138	150 / 16	0.42	700	760
1400	169	150 / 16	0.47		
1600	185	150 / 16	0.53		
1800	203	150 / 16	0.60		
2000	219	150 / 16	0.67		
2200	257	150 / 20	0.73		
2400	275	150 / 20	0.80		

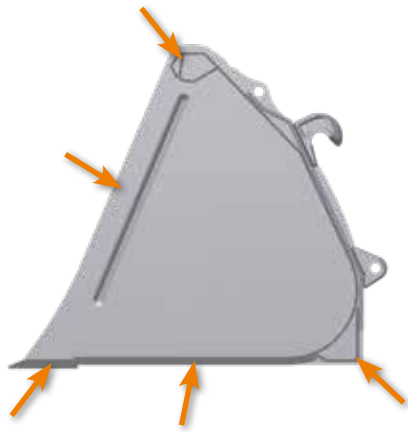

HEAVY-DUTY EARTH BUCKET – ES-V

- For heavy-duty applications
- Stronger and more under-bucket wear strips
- Extra thick side plates
- Stiffening angle on the top edge
- Stronger scraping angle
- 20mm cutting edge (plus 4mm)
- Optional bucket teeth
- A second cutting edge is an option

Width mm	Weight kg	Cutting edge mm	Volume m ³	Height mm	Depth mm
1600	215	150 / 20	0.53	700	760
1800	235	150 / 20	0.60		
2000	254	150 / 20	0.67		
2200	274	150 / 20	0.73		
2400	295	150 / 20	0.80		
2600	331	200 / 20	0.87		



5-IN-1 MULTIFUNCTION BUCKET - MFS

- One bucket serves five different functions: loading, scraping, grappling, controlled unloading, dumping at increased height
- Right-angle rear edge for scraping in reverse
- The moving part of the scoop features the robust box girder design
- Three cutting edges are standard specification
- High-grade and hard-wearing steel cutting edge (approx. 450 HB)

Width mm	Weight kg	Cutting edge mm	Volume m ³	Max. jaw opening mm	Height mm	Depth mm
1600	363	150 / 16	0.53	960	700	760
1800	391	150 / 16	0.60			
2000	418	150 / 16	0.67			
2200	469	150 / 20	0.73			
2400	500	150 / 20	0.80			

LIGHT MATERIAL BUCKET LONG VERSION – LGS-L



- Handles light materials like snow, grain, woodchips
- Curved design for easy removal of sticky materials
- Right-angle rear edge for scraping in reverse
- High-grade and hard-wearing steel cutting edge (approx. 450 HB)
- A second cutting edge is an option

Width mm	Weight kg	Cutting edge mm	Volume m ³	Height mm	Depth mm
1800	223	150 / 16	0.92	800	1000
2000	239	150 / 16	1.02		
2200	269	150 / 20	1.12		
2400	285	150 / 20	1.23		

LIGHT MATERIAL BUCKET LONG AND REINFORCED – LGS-LV

- For heavy-duty applications
- Base reinforced by extra and stronger wear strips
- Extra thick sides
- Reinforced scraping angles at the base
- 20mm cutting edge (plus 4mm)
- A second cutting edge is an option



Width mm	Weight kg	Cutting edge mm	Volume m ³	Height mm	Depth mm
2000	282	150 / 20	1.02	800	1000
2200	304	150 / 20	1.12		
2400	326	150 / 20	1.23		
2600	367	200 / 20	1.34		

LIGHT MATERIAL BUCKET SHORT VERSION – LGS-K

- Identical with the light material bucket (long version)
- The shorter design and reduced capacity suit smaller loaders
- A second cutting edge is an option

Width mm	Weight kg	Cutting edge mm	Volume m ³	Height mm	Depth mm
1800	183	150 / 16	0.68	670	870
2000	198	150 / 16	0.76		
2200	222	150 / 20	0.84		
2400	237	150 / 20	0.92		



UNIVERSAL BUCKET – UVS

- for loading larger volumes of heavy bulk materials as for example gravel with large front loaders
- 2 webs inside, stiffening angle on the top edge inside, reinforced linkage with SWE-Euro
- A second cutting edge is an option



Width mm	Weight kg	Cutting edge mm	Volume m ³	Height mm	Depth mm
2400	395	150 / 20	1.23	800	1000
2600	442	200 / 20	1.34		



HIGH-VOLUME BUCKET – GVS

- Handles large volumes of light materials such as fertiliser granules, bark mulch or woodchips
- Maximum stability from stiffeners and a web in the middle of the bucket
- High-grade and hard-wearing steel cutting edge (approx. 450 HB)
- A second cutting edge is an option
- Two webs are an option



Width mm	Weight kg	Cutting edge mm	Volume m ³	Height mm	Depth mm
2000	351	150 / 20	1,70	1030	1220
2200	374	150 / 20	1,90		
2400	419	200 / 20	2,10		
2600	444	200 / 20	2,30		



HIGH-TIP LIGHT MATERIAL BUCKET – HK-LGS

- Perfect for filling high-sided trailers, containers and truck trailers with over 4m height
- 1,500mm extra dump height
- The ideal bucket for grain and woodchips
- Curved design for easy removal of sticky materials
- High-grade and hard-wearing steel cutting edge (approx. 450 HB)

Width mm	Weight kg	Cutting edge mm	Volume m ³	Height mm	Depth mm
2000	455	150 / 20	1.00	940	1130
2200	475	150 / 20	1.12		
2400	500	150 / 20	1.23		
2600	520	150 / 20	1.34		



HIGH-TIP SILAGE GRAB - HK-SGS

- Loads towards a wall with down holder opened
- 1,500mm extra dump height
- Sturdy grab with curved tines and powerful hydraulic rams
- Side tines on the down holder are a standard feature
- High-grade and hard-wearing steel cutting edge (approx. 450 HB)

Width mm	Weight kg	Cutting edge mm	Volume m ³	Max. jaw opening mm	Height mm	Depth mm
1800	680	150 / 20	1.00	1430	700	870
2000	703		1.10			
2200	743		1.25			
2400	774		1.35			
2600	815		1.45			



SILAGE GRAB – SGS

- Sturdy grab with curved tines and powerful hydraulic rams
- Side tines on the down holder are a standard feature
- High-grade and hard-wearing steel cutting edge (approx. 450 HB)
- A second cutting edge is an option

Width mm	Weight kg	Cutting edge mm	Volume m ³	Max. jaw opening mm	Height mm	Depth mm
1600	450	150 / 20	0.75	1320	700	870
1800	492		0.85			
2000	517		0.95			
2200	567		1.05			
2400	593		1.15			
2600	635		1.25			



SILAGE GRAB – SGS-2

- Loads towards a wall with down holder opened
- Sturdy grab with curved tines and powerful hydraulic rams
- Side tines on the down holder
- High-grade and hard-wearing steel cutting edge (approx. 450 HB)
- A second cutting edge is an option

Width mm	Weight kg	Cutting edge mm	Volume m ³	Max. jaw opening mm	Height mm	Depth mm
1600	469	150 / 20	0.77	1320	700	1020
1800	513		0.87			
2000	539		0.97			
2200	592		1.07			
2400	619		1.18			
2600	663		1.28			

SILAGE GRAB FORK – SGG

- Removes grass and maize silage and handles solid manure
- Sturdy and heavy-duty tines are threaded into conical sleeves
- Sturdy down holder with curved tines and high-power rams
- Side tines on the down holder are a standard feature



Width mm	Weight kg	Tines nr.	Volume m ³	Opening mm	Height mm	Depth mm
1800	492	12	0,85	1320	700	810
2000	530	13	0,95			
2200	557	14	1,05			
2400	603	16	1,15			

MANURE FORK - DG



- Thick-walled steel tube with welded-in sleeves
- Conical sleeves ensure tight-fit tines
- Choice of two tine lengths
- Strong back wall for maximum stability

Width mm	Weight kg	Tines nr.	Tine length mm
1200	117 / 127	7	800 / 1000
1400	130 / 141	8	
1600	143 / 156	9	
1800	157 / 172	10	
2000	170 / 186	11	
2200	184 / 200	12	

BEET BUCKET – RK

- Bespoke design for efficient yet gentle handling of beet crop
- Generous spacings allow soil to drop from the load
- Large volume for fast loading cycles
- Low operating weight for high payloads



Width mm	Weight kg	Volume m ³	Height mm	Depth mm
1800	238	1,10	1000	1070
2000	255	1,20		
2200	272	1,30		
2400	290	1,50		



MULTI CROCO BUCKET – MKS

- Specifically designed for compact wheel loaders and skid-steers
- Curved design for easy removal of sticky materials
- Loads towards a wall with down holder fully opened
- Low operating weight
- High-grade and hard-wearing steel cutting edge (approx. 450 HB)
- Side plates and an extra cutting edge are options

Width mm	Weight kg	Cutting edge mm	Volume m ³	Max. jaw opening mm	Height mm	Depth mm
1000*	195	150 / 16	0.36	1075	655	705
1200*	217		0.43			
1400	236		0.50			
1600	256		0.58			
1800	277		0.65			
2000	308		0.72			

* 1000 - only with loader carriage of compact loaders; 1200 - only with Euro carriage or loader carriage of compact loaders

MULTI CROCO FORK - MKG

- Specifically designed for compact wheel loaders and skid-steers
- Low operating weight
- Curved back for easy removal of sticky materials
- Conical sleeves ensure tight-fit tines



Width mm	Weight kg	Number of tines	Volume m ³	Max. jaw opening mm	Height mm	Depth mm
1000*	185	6	0.36	1075	655	705
1200*	197	7	0.43			
1400	213	8	0.50			
1600	232	9	0.58			
1800	250	10	0.65			
2000	275	11	0.72			

* 1000 - only with loader carriage of compact loaders; 1200 - only with Euro carriage or loader carriage of compact loaders



MULTI GRAB BUCKET- MGS

- Massive down holder suits all kinds of work
- Curved design for easy removal of sticky materials
- Large jaw opening
- High-grade and hard-wearing steel cutting edge (approx. 450 HB)
- Side plates and an extra cutting edge are options

Width mm	Weight kg	Cutting edge mm	Volume m ³	Max. jaw opening mm	Height mm	Depth mm
1400	307	150 / 16	0.80	1300	805	845
1600	338	150 / 20	0.94			
1800	366	150 / 20	1.06			
2000	403	150 / 20	1.18			
2200	433	150 / 20	1.30			

MULTI GRAB FORK - MGG

- Massive down holder suits all kinds of work
- Curved back for easy removal of sticky materials
- Large jaw opening
- Conical sleeves ensure tight-fit tines



Width mm	Weight kg	Number of tines	Volume m ³	Max. jaw opening mm	Height mm	Depth mm
1400	274	8	0.80	1300	830	875
1600	296	9	0.94			
1800	317	10	1.06			
2000	351	11	1.18			
2200	373	12	1.30			



BALE FORK – BTG 4

- Large opening suits all types of round bales
- Protective rollers for gentle handling of silage bales
- Ideal tine length avoids damaging other bales in the stack
- Combined three-point/Euro carriage is an option
- Optional equaliser bar opens the spikes in synch.
- Strong back wall for maximum stability



Weight kg	Bale support length mm	Opening mm
180	1050	660–1560

SILAGE BALE GRAB – SBZ 915

- Perfect opening for silage bales
- Check valve ensures firm grip of silage bales
- Optional mounting plates for attachment to 3-point / Euro carriage
- Optional mounting plates for attachment to 3-point / Hauer carriage
- Optional 3-point attachment



Weight kg	Bale diameter mm
187	950 - 1500

ROUND BALE GRAB - RBZ 919

- Large opening thanks to specific kinematics
- Check valve for optimum grip
- Pivot pins in replaceable bronze bushings
- Reduced 1,500mm jaw opening by refitting the arms



Weight kg	Bale diameter mm
237	900 - 1900

SQUARE BALE GRAB - QBZ

- for handling square wrapped silage bales as well as straw and hay bales up to 1500kg
- Check valve for optimum grip
- optional anti-slip device with tubes at the back, that can be retracted into pipes for unhampered visibility



Weight kg	Opening mm
330	600–2000

BIG BALE FORK - GBG

- Ideal for transporting round and square bales
- Two robust big bale tines are standard specification
- Accepts up to five tines
- The tines are threaded in welded conical sleeves

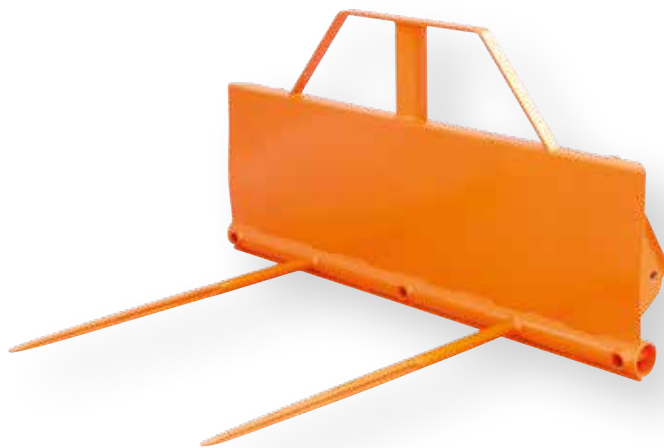

Width mm	Weight kg	Number of tines	Tine length mm	Height mm
1500	101	2-5	1100	790
	105	2-5	1400	790

PALLET FRAME WITH BIG BALE TINES - PR-GBZ

- Handles big bales
- The big bale tines can be retrofitted to the Hauer pallet frame
- Also available for ISO-FEM 2B pallet frames

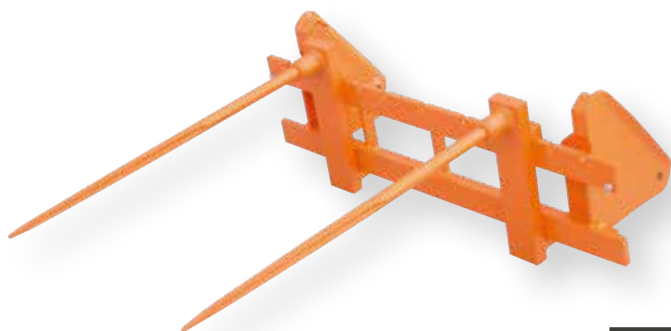

Width mm	Weight kg	Tine length mm	Carrying capacity mm
1300	125	1100	2000





PUSH-FIT STOP TUBES

- Accessories for handling big bales
- Specified for the Hauer pallet frame
- The posts prevent square bales from slipping towards the tractor cab

Height mm	Weight kg
2000	71



PUSH-ON TUBES

- For gentle handling of round bales
- The tubes are pushed on to the pallet tines
- Quick-fitting pin system

Pallet fork tines mm	Tine size mm	Weight kg
960	80 / 40	32
1100	100 / 40	33



PALLET FORK – PG

- Versatile and efficient attachment
- Forged, high-grade tines
- Milled carriage for accurate control of tine spacing
- Also available with 3-point attachment

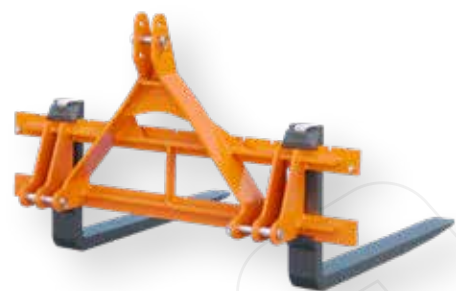

Tine length mm	Tine size mm	Weight kg	Carrying capacity kg
960	80 / 40	148	1600
1100	100 / 40	175	2000
1200	100 / 40	182	2000

PIVOTING PALLET FORK – PG-D

- Special design for emptying boxes and containers and filling seed hoppers
- The tines are adjustable and can be secured in position



Tine length mm	Tine size mm	Weight kg	Rotation °	Carrying capacity kg
960	80 / 40	295	160 left and right	1600
1100	100 / 40	321		2000
1200	100 / 40	329		2000



UNIVERSAL BOX HOLDER – KH

- Accessory for the pivoting pallet fork
- Empties boxes to the side so these do not tilt
- Arms adjust to various box sizes

Weight kg	Arm length mm	Opening mm
49	700	1000 - 1500

PALLET FORK WITH HYDRAULIC LATERAL FRAME ADJUSTMENT – PG-HS

- Fast tine adjustment left and right
- Convenient load shifts

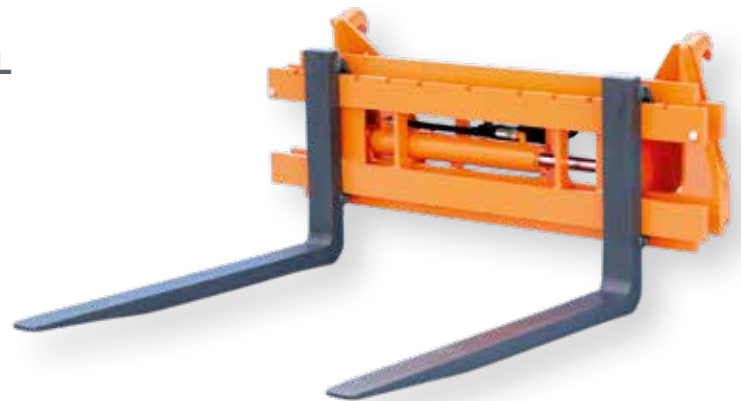

Tine length mm	Tine size mm	Weight kg	Carrying capacity kg
960	80 / 40	261	1600
1100	100 / 40	288	2000
1200	100 / 40	295	2000

PALLET FORK ISO FEM II B

- with pallet frame 1300 mm width available
- ISO-FEM II tine attachment



Pallet frame mm	Weight kg	Frame height mm
1300	100	407

Tine length mm	Weight kg	Tragkraft kg
960	78	1600
1100	103	2000
1200	109	2000

PALLET FORK ISO FEM III B

- with pallet frame in 3 different widths available (1300, 1500, 2000 mm)
- ISO-FEM III tine attachment

Pallet frame mm	Weight kg	Frame height mm
1300	190	508
1500	215	508
2000	287	508

Tine length mm	Weight kg	Tragkraft kg
1100	120	3000
1200	130	
1500	185	
1800	190	
1100	170	5000
1200	185	
1500	230	
1800	280	
2200	340	

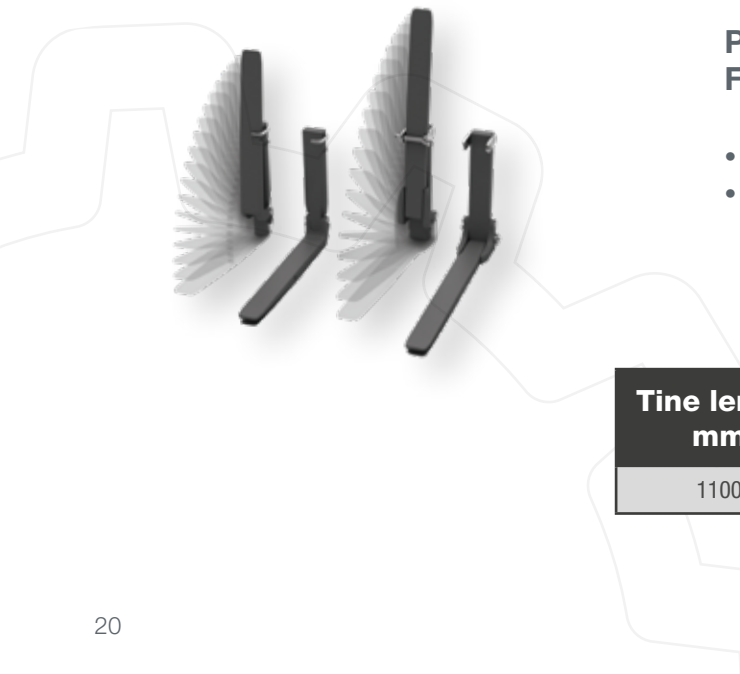

PALLET FORK WITH FOLDABLE TINES – PG-K

- Enhanced road safety
- Quick-fit mechanism folds the tines upward

Tine length mm	Tine size mm	Weight kg	Carrying capacity kg
1100	100 / 40	190	2000

MOUNTED STACKER 1700 POM – AS

- Increases the lift height of a pallet fork or safety cage by 1,700mm
- Integrates an external and an internal mast that offer infinitely variable height control
- High payload at maximum lift height
- A tipping valve is integrated in the loader's crowding line for controlled unloading.
- Pallet forks adjust from 300mm to 1,200mm in five increments
- An adapter and a tap in the lifting line are available for use with a safety cage. The adapter provides the statutory precision-fit connection between the cage and the stacker. The tap controls the lift and lowering rates.



Lift height mm	Weight kg	Lift power kg
1700	294	1000



BIG BAG LIFTER – BBL

- A specific design for handling big bags with one or several loops
- High payload for handling big bags
- Curved design for clear visibility of the tip of the hook
- Picks up and deposits big bags without operators leaving the cab
- Bolted mounting plates for quick changeovers

Weight kg	Payload kg	Height mm
119	1000	1540

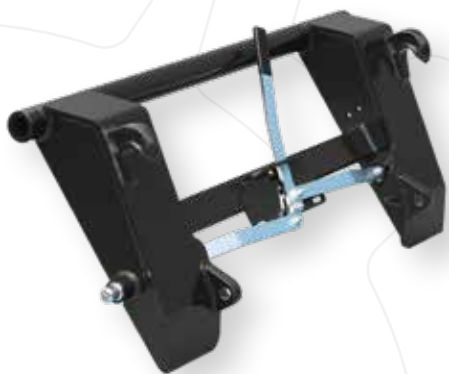

ATTACHMENT ADAPTER

- Adapts the Hauer quick-change system to attachments with EURO couplers and vice versa



CARRIAGE ADAPTER

- For attachments with EURO or Hauer couplers and third-party carriages on the loader



3-POINT ADAPTER

- For transporting three-point attachments with Cat 2 couplers to SWE Hauer or SWE EURO

3-POINT QUICK ATTACH CARRIAGE

- For attachments with Hauer or EURO couplers on a three-point linkage



SWIVEL HOOK

- XB BIONIC loaders are prepared as standard for fitting this hook
- POM-R loaders can be retrofitted with the hook including its mounting
- 360° swivel hook (endless)

Weight kg	Carrying capacity on XB Bionic kg	Carrying capacity on POM-R kg
2.5	3150	2500



SWIVEL HOOK EXTENSION ARM

- Thick-walled, sturdy tube
- Telescoping as an option

Weight kg	Length mm	Total length incl. telescoping tube mm
132	1500 / 2000	2500 / 3000



IMPLEMENT PROTECTION

- Protects cutting edges on buckets or tines on pallet forks
- Easy attachment with rubber bands
- Telescoping design for easy adjustment
- Warning tape for optimum visibility

Size	Weight kg	Width mm	Height mm	Depth mm
small	5	1240 - 1848	76	93
large	7	2040 - 2648		



3-POINT-WEIGHT

- Compact design
- Robust steel casing avoids losing concrete
- Optimum attachment points for easy attachment and removal
- Shunting hitch for work on private sites
- Standard reflective tape

Weight with concrete kg	Lower link hook category
450	2
700	2
1000	2
1250	2
1500	2
2000	2 / 3
2500	2 / 3



REAR WEIGHT

- Attached to linkage drawbar
- Made from reinforced concrete
- Available without concrete as an option for DIY purposes

Weight with concrete kg	Lower link hook category
650	1 / 2
750	1 / 2



TOOL BOX WITH BALLAST

- Practical solution to store tools
- Sealed and lockable storage room
- As standard with reflector stripes and anti-slip mat
- Additional equipment: Side marker lamps, underride protection, head light, divider, work bench, draw bar
- Weight in suitable sizes



Weight with concrete kg	Width mm	Depth mm	Height closed mm	Height opened mm	Filling volume l	Lower link hook category
450	1334	846	802	1485	380	2 / 3
700	1334	846	802	1485	380	2 / 3
1000	1634	846	802	1485	475	2 / 3
1250	1634	846	802	1485	380	2 / 3
1500	1634	960	802	1485	325	2 / 3



Side marker lamps



Underride protection, incl. side marker lamps



Work bench



Divider



Draw bar



**PREMIUM QUALITY
MADE IN AUSTRIA.**
DURABILITY - THE BASIS OF
PROFITABILITY.

All Hauer products are manufactured in our factory in Lower Austria. Premium-quality materials, advanced manufacturing technology and the long-lasting experience of our staff combine with an active quality assurance programme to give our products the durability and longevity our customers deserve.

These are the ingredients of the traditional Hauer quality made in Austria that warrants highest productivity and best value for money.

Attachments from Hauer are a pleasure to use – today and tomorrow.





THE SUITABLE ORIGINAL ATTACHMENT FOR FORESTRY.

An extract from our product range of forestry attachments.





Franz Hauer GmbH & Co KG
A-3125 Statzendorf, Werksstraße 6
Tel.: +43 (0)2786 7104-0
info@hfl.co.at | www.hfl.co.at